



# LEX

## TASK CHAIR



UNI EN 1335 part. 1/2/3 tip. B  
(only for version without headrest)

Italian 1IM approval is available in NE and TF fabrics for padded version, or NR/RV and TF/RV for mesh version, upon request

### COMPOSITION AND MATERIALS

- PLASTICS** Black or white (RAL9003) plastic structure
- STRUCTURE, PADDING**
- PA (nylon) frame with sliding seat (range 60 mm)
  - Injected foam seat padding, density 60 kg/m<sup>3</sup>
  - Height adjustable backrest in PP with up-down system (range 60mm)  
Polyurethane foam backrest padding, density 30 Kg/m<sup>3</sup>, thickness 30mm
- HEADREST** Available with height and tilt adjustable padded headrest (range 60mm), with injected foam, density 65 kg/m<sup>3</sup> (cannot be added after purchase)
- ARMRESTS**
- Black plastics
  - BRA 182 – Height adjustable plastic armrests with PU armpads
  - BRA 131 – Height adjustable polished aluminium armrests with PU armpads



- BRA 149 - 3D adjustable plastic armrests, with PU armpads  
BRA 241 – 3D adjustable aluminium armrests, with PU armpads

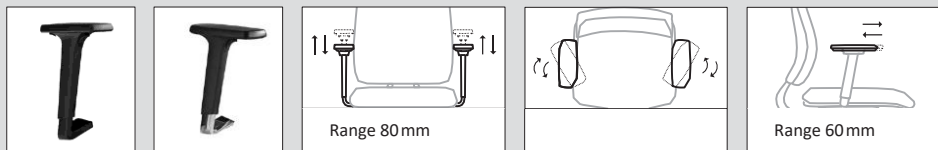

- BRA 242 – 4D adjustable nylon armrests with PU armpads  
BRA 162 – 4D adjustable polished aluminium armrests with PU armpads

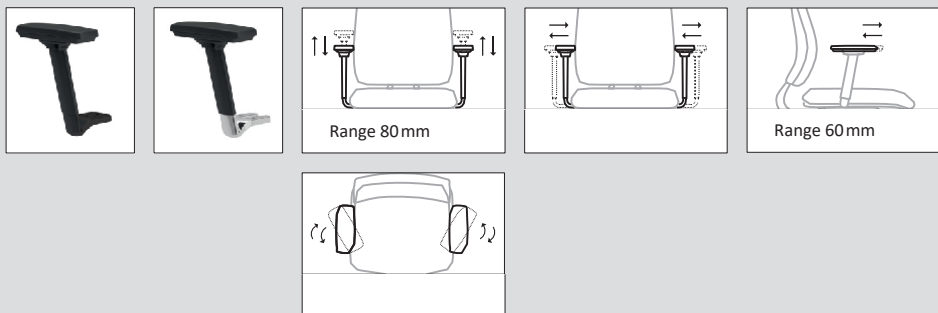

- White plastics

BRA 196 – 2D adjustable armrests with white plastic pads and chromed metal frame

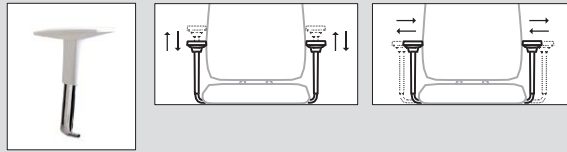

MECHANISM  
AND  
SEAT REGULATION

K – Synchronized mechanism with 5 locking positions

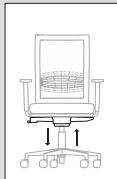
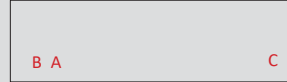

**Seat height**  
Pull the lever A upwards without sitting to increase the height of the seat. Press the lever A upwards to reduce the height of the seat.



**Tilting of the chair**  
Pull the lever B upwards to unlock the swing. Press Lever B downwards to lock in the desired position.



**Tension control**  
Turn lever C clockwise to decrease the tilting resistance. Turn lever C counterclockwise to increase the tilting resistance.



**Sliding seat**  
Press the button situated on the right side of the seat to adjust the seat depth. Release the button to lock the seat in the desired position



**Lumbar support height adjustment**  
Raise or lower the lumbar support manually, to the desired height.

BASE

B65 – 5 star aluminium base Ø 690 mm

B64 – 5 star nylon base Ø 680 mm



CASTORS



R26 – Oversize self breaking castors in PP, Ø 65 mm



R26 – Oversize self breaking castors in PP, Ø 65 mm



R27 – Hard floor oversize self-breaking castors in PP, Ø 65 mm



R27 – Hard floor oversize self-breaking castors in PP, Ø 65 mm



R28 – HOLLOWED hard floor oversize self-breaking castors in PP, Ø 65 mm



R28 – HOLLOWED hard floor oversize self-breaking castors in PP, Ø 65 mm



R21 – Oversize hard floor castors, chromed, Ø 60 mm

BASE B71 – 5 star white nylon base Ø 680mm



CASTORS



R23 – Oversize hard floor self breaking white castors in PP, Ø 60 mm



R24 – Hollowed oversize self breaking white castors in PP Ø 65 mm

DIMENSIONS,  
VOLUMES  
AND WEIGHTS

• Padded chair with headrest

cod. LEXB\_A NR BRA182 K B64 Th cod.  
 LEXB\_A NR BRA149 K B64 Th cod.  
 LEXB\_A NR BRA242 K B64 Th cod.  
 LEXB\_A NR BRA131 K B65 Th cod.  
 LEXB\_A NR BRA241 K B65 Th cod.  
 LEXB\_A NR BRA162 K B65 Th

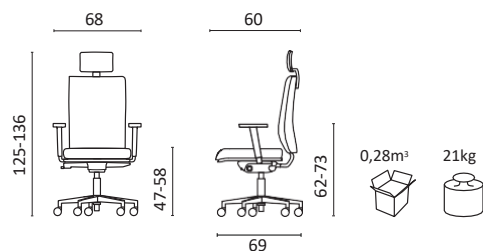

• Padded chair

cod. LEXB\_A NR BRA182 K B64 T  
 cod. LEXB\_A NR BRA149 K B64 T  
 cod. LEXB\_A NR BRA242 K B64 T  
 cod. LEXB\_A NR BRA241 K B65 T  
 cod. LEXB\_A NR BRA131 K B65 T  
 cod. LEXB\_A NR BRA162 K B65 T

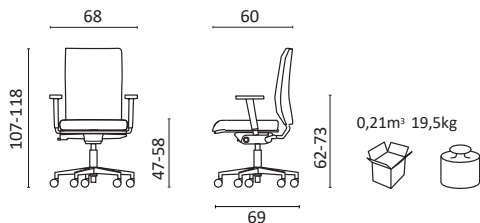

cod. LEXB\_A BI BRA196 K B71 T  
 cod. LEXB\_A BI BRA196 K B65 T

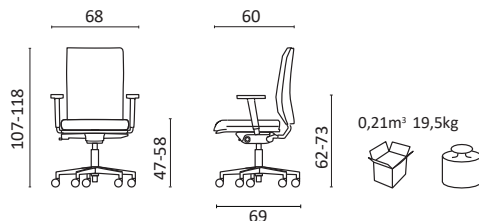

Product coder refer to Milani 2018 pricelist.

## DATA SHEET

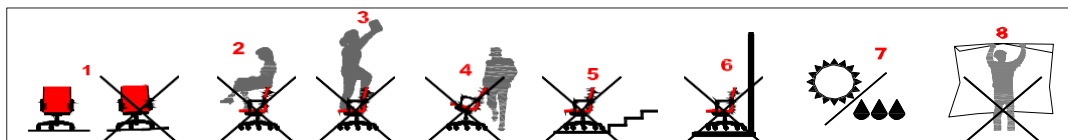

### GENERAL INFORMATION

During video terminal use, ensure your feet are firmly on the floor; the angles between calf and thigh, thigh and upper body, forearm and shoulder, shall form a 90° angle. The knee shall be close to the front edge of the seat.

- 1) The seat shall be only used on flat and clean surfaces, avoiding uneven floors (ducts, joints etc..)
  - 2) The seat can only be used by one person at a time.
  - 3) Never stand with the feet on the chair; never sit on the armrests or on the outer edge of the seat.
  - 4) Do not remove knobs or screws and, in the case of broken, missing or worn parts, do not use the chair until they are duly replaced with suitable spare parts supplied by Milani Srl.
  - 5) Avoid use near dangerous objects or places (cables, steps, stairs, doors, windows, etc.).
  - 6) Avoid use near walls or objects that may be damaged.
  - 7) Do not expose the chair to direct sunlight or in excessively humid environment, do not use outdoors: the upholstery may be irreparably damaged.
  - 8) Do not use the packaging improperly: it may cause chocking.
- The product is intended for its normal use , in offices and similar environments.

Useful information on castors choice:

Nylon self-breaking castors: suitable for normal floors and carpets; equipped with a self-breaking device that ensures higher safety.

Self-breaking rubber castors: suitable for delicate floors (e.g. parquet). Equipped with a soft tread to ensure greater resistance on the floor and a self-braking device for higher safety.

Product maintenance:

Check periodically (at least every month) that all the screws are firmly fixed.

Periodically lubricate (at least every 6 months) the mechanical parts subject to movement, in particular gas lifts, which can be only replaced by qualified personnel in case of breaking or malfunction .

Periodically clean the castors according to the environmental conditions (at least every 3 months).

Any upholstered part covered with fabric shall be cleaned with a brush or vacuum cleaner, any upholstered part in natural or artificial leather shall be cleaned with a clean, damp and soft cloth; for difficult stains use specific delicate detergents following the specific product instructions ; all other parts (plastic, metal, wood) must be cleaned with a damp cloth. Do not use alcohol-based products, bleach, solvents or abrasive products (it is advisable to try first on a non-visible part).

For any problem ask for the assistance of qualified personnel.

### WARRANTY

The warranty includes free replacement of all moving mechanical parts subject to wear: castors, gas lift, mechanisms in general, provided that the defects are not caused by misuse or improper use of the product . Transport and delivery costs will be charged to the customer starting from the second year from sale. The warranty is applicable only providing all information related to the product (specifying model, code and purchase document) Repairs can be made:

- 1) In case the defect is defined, parts will be shipped and replaced .
- 2) In case the defect has to be defined, shipping out the seat to Milani S.r.l. with suitable packing by designated courier. If after checking the product, Milani S.r.l. will reckon that the defect was caused by the customer, will charge all related costs including transport.

### DISPOSAL INFO

Here you can find a list of materials used in our production process, in order to adopt a correct approach to recycling and disposal :

Wood: beech or birch plywood, chipboard, hardboard

Metal: iron, steel, die-cast aluminum

Plastics: PVC, polypropylene, polyurethane, nylon

Fabrics: natural leather, artificial leather, fabric, mesh

Our products do not contain harmful or potentially dangerous substances.

## DATA SHEET

### CERTIFICATIONS

Milani S.r.l. has obtained the following certifications :

UNI EN ISO 9001 Quality management system according to UNI norms

EN ISO 14001 Environmental management system

OH SAS 18001 Work safety management system